

Virtual Prototyping, Identification and Control of a Twin Rotor with 3DOF

Bruno M. Shimada¹, Lucas Niro², Eduardo H. Kaneko³, Matheus F. Mollon⁴, Wagner de S. Chaves⁵, Marcio A. F. Montezuma⁶

¹MSc Mechanical Engineering, University of Technology - Paraná, Cornélio Procópio, Paraná, Brazil
Email: brunoshimada@gmail.com¹

^{3,4,5}Graduate Student, University of Technology - Paraná, Cornélio Procópio, Paraná, Brazil
Email: eduardok@alunos.utfpr.edu.br³, matheusmollon@alunos.utfpr.edu.br⁴, wagner_souza92@hotmail.com⁵

^{2,6}Department of Mechanical Engineering, University of Technology - Paraná, Cornélio Procópio, Paraná, Brazil
Email: lucasniro@utfpr.edu.br², montezuma@utfpr.edu.br⁶

Abstract—This paper presents a methodology for identification of the physical characteristics, generation of the mathematical model through virtual prototyping and control of the didactic plant of a twin rotor. In the identification of the physical characteristics, the centers of mass and moments of inertia of the twin rotor parts were identified separately, by means of an easel designed for such task. Still in the identification of the physical characteristics, the equation that relates the applied voltage in the direct current motor with the thrust force produced by the propellers was obtained. The mathematical model of the twin rotor was obtained by means of the identification of the physical characteristics allied to the virtual prototyping with the aid of ADAMS and SolidWorks software. The implemented control system uses state feedback and complete eigenstructure assignment. The ease and usefulness of the proposed methodology was presented through the plant instrumentation, simulation and control in MATLAB/Simulink environment.

Keywords—Control Systems, Parameters Identification, Virtual Prototyping.

I. INTRODUCTION

Largely, the study of engineering control systems has been limited to simulations and mathematical studies, and is occasionally implemented in a real plant. In this context, laboratories are necessary to test and implement a control system in order to validate data on a real plant. However, according to [1] experimentation tends to make high the investment in equipment and facilities that a teaching and research institution should set up if it wants to reach a level of quality in this field. In addition to the high cost, the study in a real plant takes a long time to build a desired model, leaving the focus, which is the study of control systems, in the background.

This scenario has required the construction of didactic plants that are affordable in terms of the study of modern control systems. One of the plant models widely used among researchers to study control systems, and on which this article is based, is a didactic plant of an aircraft of two parallel propellers with three degrees of freedom (3DOF). The dynamics of this aircraft resemble a tandem helicopter e.g. the CH-47 Chinook military helicopter, produced by Boeing. Helicopters are also known for their open-loop instability and difficult control, requiring a lot of skill from the pilots.

The difficulty in controlling a helicopter leads the manufacturers to equip these aircraft with some kind of assistance to the pilot by means of automatic controls of orientation, speed or altitude, in order to reduce piloting efforts [2]. The large dependence between its control variables makes it necessary to implement multivariable controls or commonly called Multiple-Input Multiple-Output (MIMO), which is a challenging task [3]. For this, modern controllers are implemented so that a helicopter presents a more stable dynamic behavior. These characteristics demonstrate the importance of the study of control systems in a helicopter plant.

Modern control strategies are techniques based on mathematical modeling and the use of non-linear control methods or approximations of linear controls to the plant. Often, the mathematical formulation of dynamic models presents a high degree of complexity, which becomes very exhaustive for mathematical modeling without the aid of computational tools. For this, there are currently computational tools that help in this stage of modeling. The tools for implementations through computer software in the field of simulation of multibody systems are known as "virtual prototyping". Through virtual prototyping one can construct and test representative virtual prototypes, obtain mathematical models, perform simulations both

visually and mathematically and simulate the complete behavior of complex mechanical system movements.

In this context, this work presents the development and implementation of a control system with state feedback and the complete eigenstructure assignment to control the elevation and travel of a helicopter plant with two parallel propellers with 3DOF. It is also presented the identification of the inertial characteristics through experimental methods and generation of the model through virtual prototyping using ADAMS software, which uses multi-body modeling techniques to obtain the dynamic plant equations, facilitating the modeling process. The work is organized as follows. Section II shows the plant to be controlled. Section III describes the identification of the inertial characteristics of the aircraft plant. In section IV it is shown the creation of a virtual prototype. Section V presents the development of the control system. In section VI it is presented the simulation in MATLAB/Simulink environment, instrumentation of the plant and experiments. Section VII presents the conclusions.

II. TWIN ROTOR

This work was carried out in a didactic plant of a parallel propeller aircraft developed at the Laboratory of Automated Systems and Control (LaSisC) of the Federal University of Technology – Paraná (UTFPR). The aircraft plant was based on the 3DOF Helicopter model produced by Quanser [4], and is presented in Fig. 1.



Fig. 1: 3DOF Twin Rotor.

The plant consists of two parallel propellers with 3DOF, but only two controllable degrees. The plant of the aircraft has four main parts, namely: the base, the vertical rod, the support arm and the body of the aircraft. Fig. 2 shows the disassembled plant to best present these four pieces.

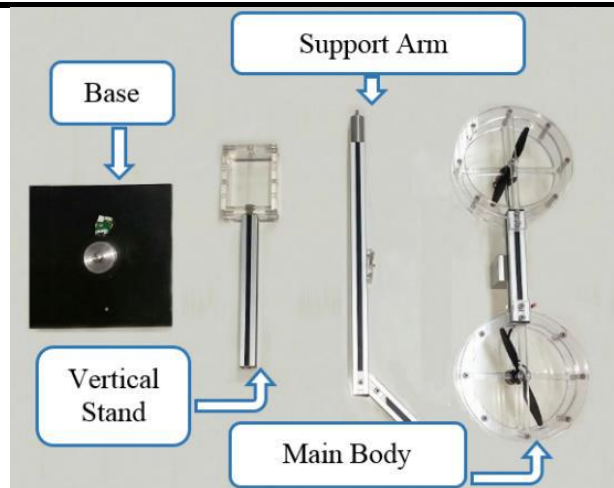

Fig. 2: Parts of the 3DOF Twin Rotor.

In the three rotation joints are mounted encoders to measure the angles of the movements and two motors of direct current with propellers are mounted in the main body of the helicopter to generate the forces of thrust. Through the thrust forces generated by the propellers and the 3DOF obtained from the constraints caused by the rotary joints, one can describe the dynamics of the system shown in Fig. 1.

III. IDENTIFICATION OF THE AIRCRAFT PHYSICAL CHARACTERISTICS

In the identification of the inertial characteristics, the parallel propeller aircraft was disassembled and each part was considered as a rigid body and thus identified separately. The four main parts of the aircraft were considered as a rigid body: the base, the vertical rod, the support arm and the body of the aircraft, shown in Fig. 2. In the experiment to obtain the centers of mass of each piece was used the method of the static reactions described in [5] and illustrated in Fig. 3.

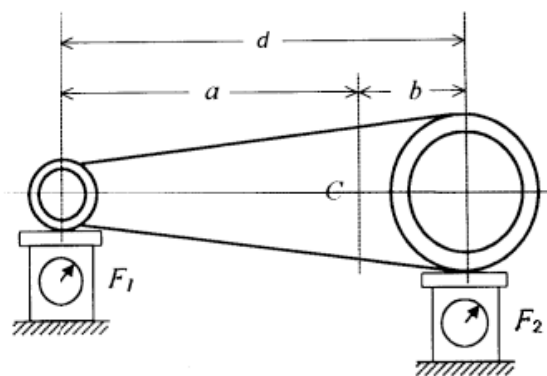

Fig. 3: Experiment to obtain the center of mass [5].

In the experiment to determine the moments of inertia in relation to the main axes of the rigid bodies, indispensable to obtain the mathematical model or the virtual prototype, the pendulation method presented in [5] and shown in Fig. 4 was used.

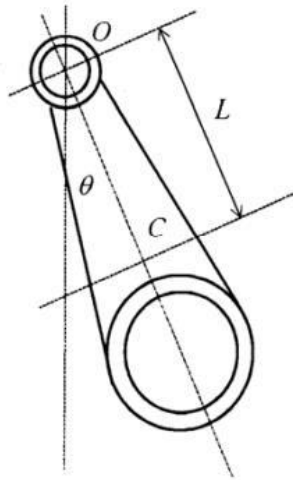

Fig. 4: Experiment to obtain the moments of inertia [5].

In the test to obtain the centers of mass, similar to the experiment of Fig. 3, the principle is to use two load cells arranged with a known distance d between them. Thus the variables are F_1 , F_2 and d . The weight of the body F_c , concentrated at the point C is obtained by the sum of the reactions F_1 and F_2 . From the principle of $\sum M_o=0$ the variables a and b that determine the center of mass are obtained.

The moment of inertia determination test, shown in Fig. 4, consists of placing a rigid body to oscillate around an axis. The value of the oscillation angle θ must be small and the oscillation period T must be measured. The moment of inertia is obtained by applying the equation of motion to the part with respect to point O , as shown in (1).

$$-mgL \sin \theta = I_o \frac{d^2 \theta}{dt^2} \dots \dots \dots (1)$$

In (1) the variable m is the mass of the body and g is the acceleration of gravity. Considering that the piece on balance will suffer small oscillations, we adopt $\sin \theta = \theta$ in order to obtain the linear differential equation presented in (2).

$$\frac{d^2 \theta}{dt^2} + \frac{MgL}{I_o} \theta = 0 \dots \dots \dots (2)$$

Solving (2) we have the moment of inertia with respect to the point O , given by (3).

$$I_o = mgL \frac{T^2}{4\pi^2} \dots \dots \dots (3)$$

The moment of inertia I_c in relation to the axis that passes through the center of mass C , using the theorem of parallel axes is given by (4).

$$I_c = I_o - mL^2 = mL^2 \left(\frac{T^2 g}{4\pi^2 L} - 1 \right) \dots \dots \dots (4)$$

The identification of the inertial characteristics of the plant was carried out on the easel developed in [6], shown in Fig. 5.



Fig. 5: Easel for identification of the plant physical characteristics [6].

Still as an integral part of the aircraft identification, a test was carried out to determine the relationship between the thrust forces (N), generated by the propeller, and the voltage (V) applied to the motors, the structure of this test is shown in Fig. 6.

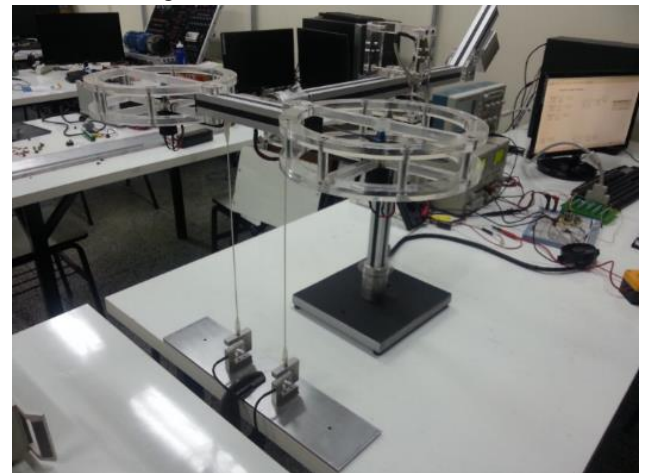

Fig. 6: Experiment to obtain the thrust forces performed by the motors.

Table 1 shows the non-symmetrical mass centers obtained by the experimental test, considering that the main body has three axes of symmetry, the vertical stand has two and the support arm only one.

Table 1: Non-symmetric center of mass of the parts.

Part	Coordinate	Center of Mass (mm)
Vertical	Y	268.18

Stand		
Support Arm	X	-344.78
Support Arm	Y	12.15

Table 2 shows the moments of inertia obtained in the experimental trial. As the support arm has only one plane of symmetry, it is not possible to state that the directions of the main axes of moment of inertia are coincident with the coordinate system adopted. Thus, in order to determine the direction of the main inertia axes x and y , it is necessary to measure a moment of inertia I_{OL} on an axis with a known angle which is contained in the plane of symmetry. Therefore, it is possible to determine the product of inertia, the principal moments and its orientation α by the Mohr circle theory using the known values of I_x, I_y, I_{OL} and the direction cosines λ_x and λ_L . For the repeatability of the method used, two measurements of the moment of inertia I_{OL1} and I_{OL2} , both with different known angles, were taken and then averaged. The values of I_{max} and I_{min} correspond respectively to the main axes of moment of inertia, and have direction α with respect to the adopted axes x and y . The results obtained for the two different angles in the experiments were close, validating the methodology by the Mohr circle. The α angle found was 5.35° .

Table 2: Non-symmetric moments of inertia of the parts.

Part	Coordinate	Experimental (g.mm ²)
Vertical Stand	X	10,292,220.45
Vertical Stand	Y	531,608.77
Vertical Stand	Z	10,853,816.96
Main Body	X	37,955,992.41
Main Body	Y	4,017,730.79
Main Body	Z	41,203,218.46
Support Arm	I_{max}	38,442,548.43
Support Arm	I_{min}	672,100.80
Support Arm	I_z	38,865,747.10

In the experiment of Fig. 6 the support arm was placed horizontally and in equilibrium. The thrust forces were considered normal to the plane of the propellers and to the ground. The aerodynamic effects as a function of distance and angle on the ground, the so-called "soil effect" were disregarded. For measurement of the thrust force, the two load cells previously calibrated for the center of mass test were used. One end of the load cells was fixed to the ground by means of a support made of aluminum. The

other end of the load cells was attached to the body of the helicopter by means of fiberglass rods of negligible mass. At first a test was performed varying the Pulse-Width Modulation (PWM) from 0 to 100%, but it was verified that the motor heats up and loses efficiency to values above 50%. Table 3 presents the results of the test conducted from 0 to 50%, which decreases the motor heating.

Table 3: Thrust force relative to PWM.

Average motor voltage (%)	Thrust force (N)
0	0.0041
10	0.1710
20	0.4210
30	0.6462
40	0.8571
50	1.0667

By means of a linear regression of the data of Table 3, by the least squares method, the relation between the thrust force and the applied voltage to the motors was obtained and is presented in (5).

$$Y_i = 46.9345 u_i \dots \dots \dots (5)$$

IV. MODEL

From the identification of the aircraft characteristics presented in Section III, the linear and non-linear models were calculated automatically with the aid of ADAMS software. Fig. 7 shows the diagram of the method to obtain the mathematical model through virtual prototyping.

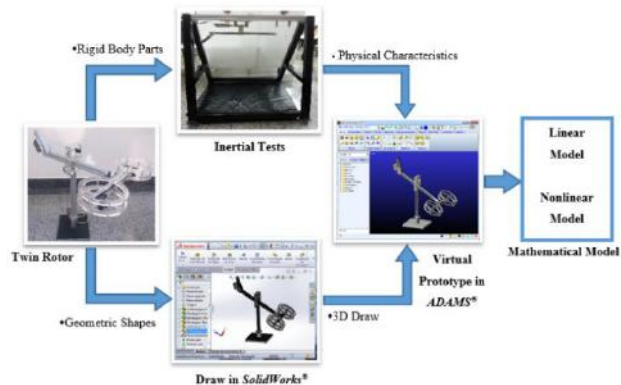

Fig. 7: Method to obtain the mathematical model.

For the linear model, the ADAMS allows to obtain the representation in the form of state space, where the plant is linearized around a defined position in the virtual prototype. For the nonlinear model, ADAMS generates a block for the Simulink, making possible the simulation between ADAMS and MATLAB/Simulink, with a dynamic animation of the plant.

V. CONTROL

A controllable open-loop system is represented by the n th-order state and p th-order output, respectively, in (6) and (7).

$$\dot{x} = Ax + Bu \dots\dots\dots (6)$$

$$y = Cx = \begin{bmatrix} E \\ F \end{bmatrix} x \dots\dots\dots (7)$$

where y is a $p \times 1$ vector and $w = Ex$ is a $m \times 1$ vector representing the outputs which are required to follow a $m \times 1$ input vector r .

According to [7] the design method consists on the addition of a vector comparator and an integrator, which satisfies (8).

$$\dot{z} = r - w = r - Ex \dots\dots\dots (8)$$

As presented in [6] the state feedback control law to be used here is given in (9).

$$u = K_1x + K_2z = [K_1 \quad K_2] \begin{bmatrix} x \\ z \end{bmatrix} \dots\dots\dots (9)$$

This control law assigns the desired closed loop eigenvalues spectrum if and only if the matrices pair (\bar{A}, \bar{B}) is controllable [7]. It has been shown that this condition is satisfied if (A, B) is a controllable pair and satisfies (10) and the controllability condition in (11).

$$\text{rank} \begin{bmatrix} B & A \\ 0 & -E \end{bmatrix} = n + m \dots\dots\dots (10)$$

$$\text{rank } M_c = \text{rank} [B \ AB \ A^2B \ \dots \ A^{n-m}B] = n \dots\dots\dots (11)$$

Satisfying the conditions in (10) and (11) guarantees that a control law in (12) can be synthesized such that the closed-loop output tracks the command input. In that case the closed-loop state equation is:

$$\dot{x}' = \begin{bmatrix} \dot{x} \\ \dot{z} \end{bmatrix} = \begin{bmatrix} A + BK_1 & BK_2 \\ -E & 0 \end{bmatrix} \begin{bmatrix} x \\ z \end{bmatrix} + \begin{bmatrix} 0 \\ I \end{bmatrix} r \dots\dots\dots (12)$$

The feedback matrix must be selected so that the eigenvalues are in the left-half plane for the closed-loop plant matrix of (12). Thus, the outputs $w(t)$ track the piecewise constant command vector $r(t)$ in the steady state. The control system is illustrated in Fig. 8. The $\ker S(\lambda_i)$ imposes constraints on the eigenvector v_i that may be associated with the assigned eigenvalue λ_i . The $\ker S(\lambda_i)$ identifies a specific subspace, and the selected eigenvectors v_i must be located within this subspace. In addition, the selected eigenvectors must be linearly independent so that the inverse matrix V^{-1} exists [5].

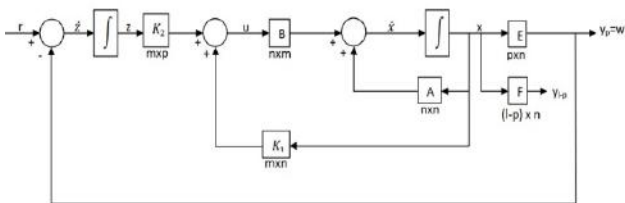

Fig. 8: Tracking system.

From the linear model represented by state-space matrices, the methodology of the tracking control system by eigenstructure assignment proposed by [7] was used to find the gains K_1 and K_2 of the control system. The eigenvalue choices were made in order to assign performance characteristics over time that are capable of stabilizing the aircraft. In this way, the chosen eigenvalues must be in the left half-plane of the complex plane and belong to the null vector space \aleph i.e. those vectors that represent the solutions to the matrix $[A - \lambda_i I \quad B]$.

VI. SIMULATIONS AND EXPERIMENTS

The workbench where the experiment was performed consists of a computer with Windows XP O.S. with MATLAB/Simulink in Real-Time Windows Target mode, the PCI-6602 card from National Instruments performs the drive of the motors and reading of the encoders. The workbench is shown in Fig. 9.

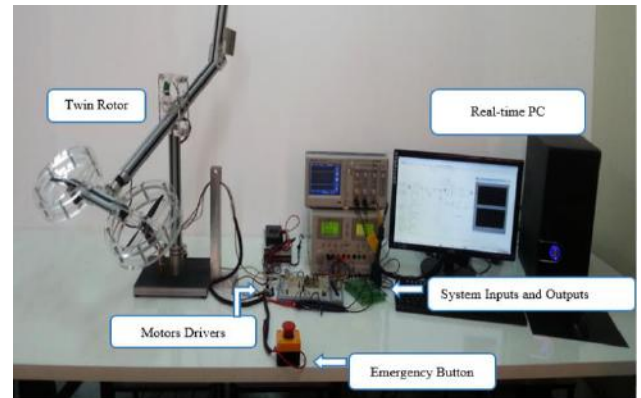

Fig. 9: Experimental workbench.

Figs. 10, 11, 12 and 13 represent the results of the experimental model for analysis of the aircraft response when subjected to the reference variation of 50° in the travel angle and 30° in the elevation angle, at the same time. It can be observed in Figs. 10 and 11 that both responses presented similar behavior to the simulation, especially when considering the time scale adopted. It was verified that the travel angle presents a slower dynamic than the response for elevation angle, as predicted in the simulation.

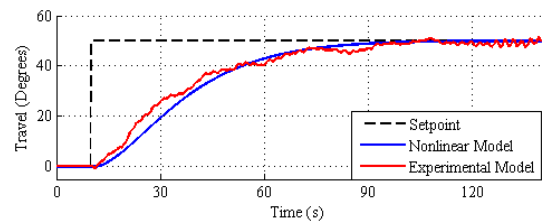

Fig. 10: Travel response to a step input of 50 degrees.

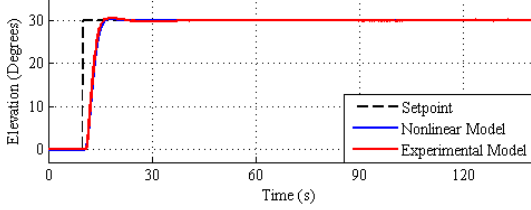

Fig. 11: Elevation response to a step input of 30 degrees.

The travel angle presented a small oscillation during the transition when compared to the response of the simulated model. This is because the mathematical model presents a singularity that happens due to the symmetry of the thrust forces generated by the arrangement of the propellers, which are parallel. In addition, there is no force acting directly on the travel movement, since the thrust forces generated by the propellers when the aircraft body is in the horizontal position are perpendicular to the travel movement. Therefore, in order to realize the travel movement, it is necessary to carry out a pitch movement to obtain a force component that can carry out the travel movement. Figs. 12 and 13 show, respectively, the pitch angle and the control action obtained in the test of the simultaneous variation in elevation and travel angles.

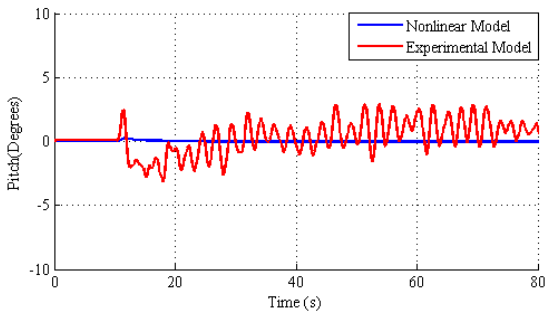

Fig. 12: Pitch response on a simultaneous step input on travel and elevation.

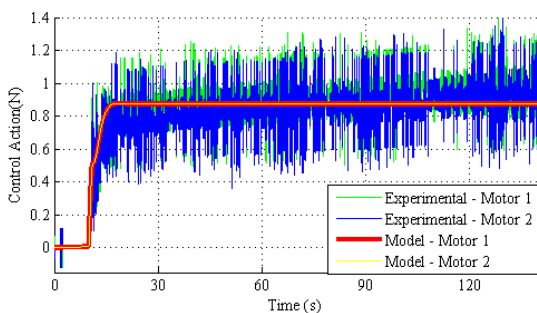

Fig. 13: Control Action on a simultaneous step input on travel and elevation.

In Fig. 12, small swings in aircraft pitch are clearly seen due to the singularity problem. Despite this oscillation and considering that the pitch angle is not a controllable variable, it can be concluded that the desired angles of travel and elevation presented satisfactory results for this experiment. Fig. 13 shows that the control action had an average behavior equal to that of the simulation and also

remained within the saturation limits of the motors. There is a slight tendency to increase the control action between approximately ten seconds and the end of the experiment. This increase occurred because the motors lose the efficiency with the increase of the operating temperature, in this way the control system must send a greater control action to obtain the same thrust of the beginning of the experiment.

Another experiment carried out analyzes the response of the system to a sinusoidal input of 0.05 Hz in the elevation angle (Fig. 14) with fixed travel angle at 0° (Fig. 15). Note that the elevation angle presented a good response when compared to the simulated nonlinear model. Theoretically, the travel angle should not present any variation, since in the variation of the elevation angle both propellers should have exactly the same control actions. However, the travel angle presented in the experiment a small variation surely caused by the torque effect previously explained.

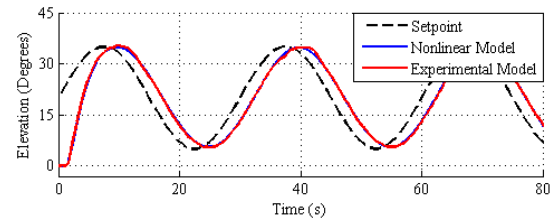

Fig. 14: Sine input on elevation.

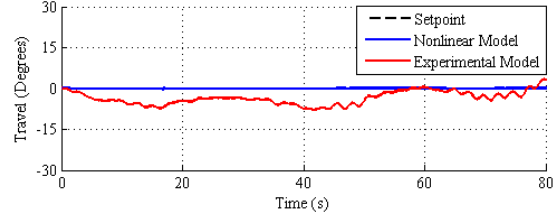

Fig. 15: Travel in response of a sine input on elevation.

In Fig. 16, it can be seen that the pitch angle oscillates near 0° to compensate for the travel movement.

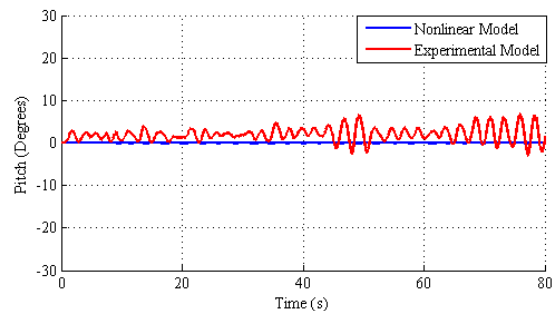

Fig. 16: Pitch in response of a sine input on elevation.

Fig. 17 shows the control action for sinusoidal input in the elevation angle, the mean of the experimental control action converged to the simulation values.

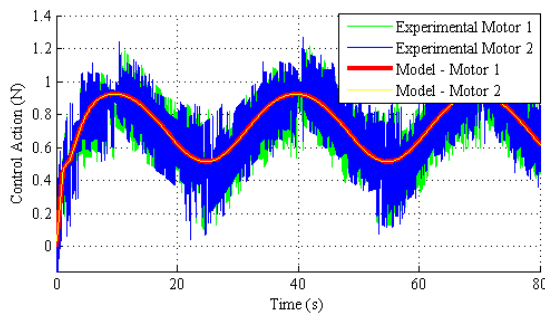

Fig. 17: Control Action in response of a sine input on elevation.

VII. CONCLUSIONS

In this paper a study was carried out on the modeling and control of an aircraft of parallel propellers with 3DOF. The main objective was to control the angle of travel and elevation of the aircraft, thus validating the obtained model, and the state feedback and assignment of complete eigenstructure control system. The methodology presented to obtain the mathematical model through the identification of the physical characteristics allied to the use of the dynamic modeling software ADAMS and CAD software SolidWorks proved to be efficient, which facilitated and made the modeling process fast when compared to the modeling where mathematical methods are used.

The acquisition system, developed in MATLAB/Simulink software using the National Instruments PCI-6602 card, met the needs of real-time implementation of the hardware-in-the-loop technique. The acquisition system was designed to allow the change of the control technique without significant change of the acquisition system, i.e. the input and output variables of the aircraft plant are made available in only one block conditioned for use. Thus, it is possible to implement different control techniques in future works, this being an important characteristic of a didactic plant.

During the experiments, it was found that the temperature of the motors significantly influences the thrust forces generated by the propellers. The control system is able to compensate for this unpredicted behavior of the motors loss of performance, when heating occurs, increasing the control action.

The experiments showed the tendency for a small error to appear in the travel angle, and it is concluded that this error is caused by the torque generated by the propellers, which turn in the same direction, thus causing a force on the axis of the travel contrary to the direction of the propellers rotation.

The pitch angle oscillated in the results of the experiments. This occurs due to the arrangement of the propellers, which are parallel to each other and perpendicular to the travel movement. When a movement of travel has to be

made, there is no force acting directly. For this, it is necessary to carry out a pitching motion to obtain a force component, which perform the travel movement.

ACKNOWLEDGEMENTS

Acknowledgements are directed to the Capes Foundation for the material and financial support, which made possible the accomplishment of this work.

REFERENCES

- [1] A. C. G. C. Diniz, J. G. Aguiar and B. A. Fellipes, Qualitysystem in university laboratories: encouraging education, research and extension. *Revista de Ensino de Engenharia*, vol. 30, no. 2, pp. 14-23, 2011.
- [2] W. V. dos Santos, Modeling, identification and altitude control of a small-scale helicopter. M.S. thesis, Federal University of Rio de Janeiro, Rio de Janeiro, 2005.
- [3] B. S. Kim, Nonlinear flight control using neural networks. Ph.D. Dissertation, Georgia Institute of Technology, Atlanta, 1993.
- [4] Quanser. 3DOF helicopter. (2017). Retrieved from: http://www.quanser.com/products/3dof_helicopter.
- [5] M. F. Mucheroni. *Mecânica aplicada às máquinas*. São Carlos: EESC - University of São Paulo, 2000.
- [6] M. A. F. Montezuma. Methodology for identification and control of a movement platform prototype with 2 D.O.F. Ph.D. Dissertation, School of Engineering of São Carlos, University of São Paulo, São Carlos, 2010.
- [7] J. D'azzo; C. Houpis. *Linear control system analysis and design: conventional and modern*. 4th ed. New York: McGraw-Hill Companies, 1995.