

Geotraceability: An Innovative Strategy for Extraction of Information and an Aid for the Sustainable Cattle Raising

Ricardo Guimarães Andrade¹, Mateus Batistella, Pedro Paulo Pires, Marcos Cezar Visoli, Thaís Basso Amaral

¹Brazilian Agricultural Research Corporation - Embrapa, Brazil

Abstract — *The requirement of traceability of information for food is an increasingly important condition for gaining the confidence and loyalty of the consumer. The concept of geotraceability arose through the association between knowledge of a geographical nature with the traditional information provided by traceability. This study explored the use of design of spatial information inherent to biophysical parameters of the pasture (vegetation indices and evapotranspiration) combined with data collection on the mobility of cattle in pasture areas for extraction and availability of spatially explicit information that can assist sustainable cattle production. From the trajectories, it was observed the existence of a typical behavioral pattern of the animals, such as the preference to walk towards clean and flat terrain, search for areas that present better thermal comfort or regions near to supplementary feeding (salt, food, etc.) and the access to water. Overall, it is noticed that in a pasture environment, the animals prioritize their primary physiological needs, that is, water consumption and thermal regulation. The results are promising in terms of applied research for behavioral analysis of animals and environmental interactions associated with mobility. The technique used in the study has the potential to be applied in the implementation of cattle production geodecision systems that support good production practices and favor the quality and safety of food with environmental sustainability.*

Keywords — *animal behavior, cattle raising, geo decision system, geo traceability, sustainability.*

I. INTRODUCTION

Consumers regard safety the most critical ingredient in food [1]. The repercussion of hazard caused by the ingestion of some food consumed in any part of the world is a piece of news that spreads in few instants, regardless of the distance of the occurrence. In this context, the requirement of traceability of food information is an

increasingly important condition for gaining confidence and loyalty of the consumer.

The application of information technology (IT) tools allows to storage, in a database livestock, activities such as animal crossing, artificial inseminations, nutritional and sanitary aspects of each animal, weight, pasture quality, animal mobility, among other data. However, when the subject is sustainable production, it is of fundamental importance that the analysis of decision-making covers a better comprehension of the impact factors of the production system. Therefore, elements essential to the environment are necessary for the implantation of a system that besides allowing safe food is also ecologically correct.

Rural environment management is directly related to the geographical space: land use and coverage, topography, climatology, soil type, water resources, among others. The study of geographic space involves a series of knowledge and information that can be more easily and quickly worked by using new technologies [2]. In the last years, the use of geotechnology and geo-information by public and private organs and companies has grown considerably, primarily to support project planning, execution, and monitoring processes [3].

By using geotechnology and geo-information in an integrated analysis of the production processes of cattle breeding, covering not only the traditional practices production at local plan or punctual level (insemination, vaccines, weighing, etc.), but also those that provide a space-temporal vision, the concept of geotraceability has arisen [4, 5, 6].

Geotraceability is the ability to describe the history, use, and location of a product, allowing the tracking and monitoring of production until its consumption [5]. The space component stands out for adding value to market products, to the certification and labeling of retail marketing and communication with consumers, with the potential to induce further policies for the sector. In short, geotraceability is defined as the association between

geographic and traditional information provided by traceability [7]. This concept emerges as an innovative and strategic alternative for evaluating the behavior of cattle in extensive production systems, being useful as a management tool aimed at improving animal welfare.

Mobility of the animals on pasture can be tracked through equipment capable of collecting and storing data on the geographic position associated with the day and the hour. These data may contribute to the extraction of information related to, for example, patterns of social organization, as animals do not disperse at random into their environment. According to Paranhos da Costa and Costa e Silva [8], this non-causality in the use of geographic space is related to the physical and biological structures of the environment, to the climate and to the social behavior.

Hence, geotraceability becomes an innovative and alternative strategy for the monitoring of bovines in the extensive production system. More specifically, this work explored the use of spatial information plans essential to biophysical parameters of the pasture (vegetation indices and evapotranspiration) combined with the data collection of the cattle mobility on the pasture for extraction and availability of spatially explicit information that can help a sustainable production of bovine animals.

II. MATERIAL AND METHODS

This study was carried out in an experimental field with Brachiaria pasture, on Beef Cattle Embrapa farm, Campo Grande, state of Mato Grosso do Sul, Brazil (Figure 1).

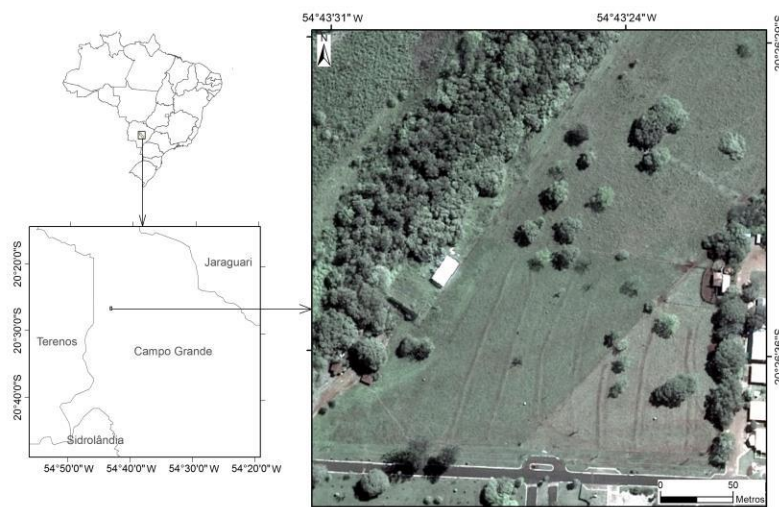

Fig. 1. Study area location. GeoEye-1 image on RGB (3,2,1) composition merged with panchromatic band.

Animal mobility data were collected through the application of GPS and transponder adapted on resistant leather collars and placed on bovines (Figure 2).



Fig. 2. Visualization of collar placement (A) and bovine already wearing the collars in experimental pasture area (B).

The collars allowed identifying the positioning of the animal in space and time. The principal elements of the electronic collars are: GPS device and its antenna, to determine the position of the animal; UHF system for communication with the base station; memory, to store the GPS data before they are transferred to the base station; a microcontroller, which manages the general

operation of the collar; and a feeding management element so the power consumption is as low as possible. Figure 3 shows the architecture of electronic collars.

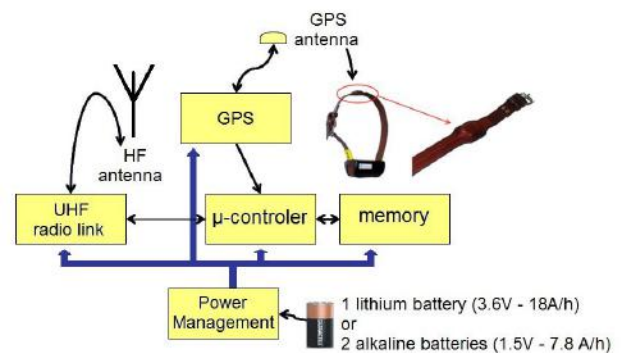

Fig. 3. General architecture of the electronic collars [9].

The positions then identified were transferred to a field base station and then forwarded to a central database. For the base of the system, base station architecture (Figure 4) has a PC104 (portable computer for embedded systems) with low power consumption with Microsoft Windows operating system; UHF (Ultra High Frequency) system

for communication with collars; power management system that controls every power supply from the base station using a battery and a solar panel. The control of the PC was carried out utilizing a touch screen connected via network. A USB connector was used to create the possibility for the operator to collect all data from the collars, which were stored in the PC memory.

The acquisition of animal mobility data was carried out as follows: in predetermined periods, the collar's micro-controller activates the GPS, synchronizes with the satellite and collects the animal's position, with subsequent deactivation of the GPS according to the programming defined by the operator, to reduce energy consumption.

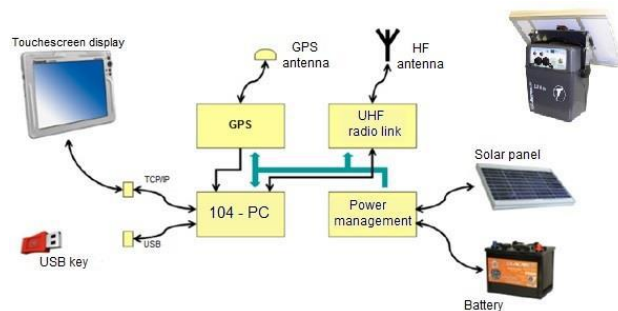

Fig. 4. General architecture of the base station [9].

Based on the collected position, the collar verifies its proximity to the base station, activates the UHF radio, and transfers the collected data to the base station. After that, data can be transmitted from the base station to the information system in two ways: (1) manually by using a flash drive; (2) automatically over a TCP/IP network. Figure 5 shows the base station set next to the balance scale (Figure 5a) and the bovine drinker (Figure 5b).

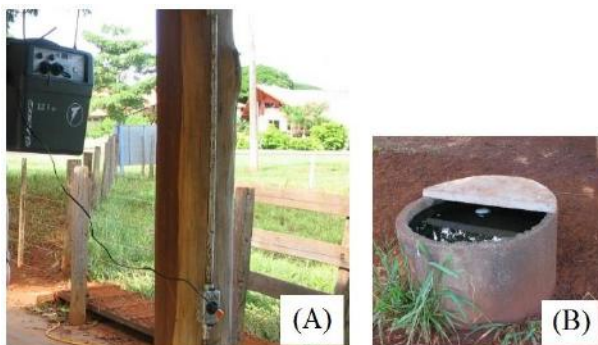

Fig. 5. Visualization of the base set next to balance scale (A) and the drinker (B).

One of the objectives of geotraceability is to be able to lead to good practices through the adoption of tools for data acquisition and treatment from different sources and formats (text, raster, and vector) and the diffusion of spatial information when using geographic information systems [7], shared through the Internet as WebGIS system, denominated SOMABRASIL [10]. In this case,

as the first step for the information management process, the animal mobility data collected through the collars were used together with remote sensing (SR) data to preliminarily evaluate the possibility of extracting information in the extensive cattle production system.

Animal mobility data were collected in March, April and May 2009. More specifically, from March 16th to 20th 2009; April 10th to 29th 2009 and on May 13th, 26th and 27th, 2009. Meteorological data (wind speed, radiation, and air temperature) were also used from INMET station located in the city of Campo Grande, state of Mato Grosso do Sul, Brazil.

The images from Landsat 5 – TM, Geoeye-1, and WorldView-2 from May 11th 2009, October 9th 2011 and April 13th, 2013, respectively, were used to evaluate the trajectories of the animals. The images were used to obtain the normalized difference vegetation index (NDVI) and evapotranspiration (ET) of the experimental picket pasture. Hence, the methodology detailed in Andrade et al. [11] was applied. Subsequently, the NDVI and ET maps were used as background information to evaluate the trajectory of the animals.

III. RESULTS AND DISCUSSION

Figure 5 shows the trajectories performed by four animals with individual records collected through collars # 0001 (Figure A), # 0003 (Figure B), # 0004 (Figure C) and # 0006 (Figure D). Image GeoEye-1 allows identification of pasture sites that have the trajectories performed by the bovines. These trajectories refer to the first evaluations of the use of bovine collars in pasture areas in the state of Mato Grosso do Sul, Brazil. The results obtained in the study were promising in terms of research applied for animal behavioral analysis and environmental interactions associated with mobility [12].

Although the pasture area is not very extensive, from the trajectories of each animal it was possible to observe the existence of a typical behavior pattern of the animals. Silveira et al. [13] observe that cattle are gregarious animals (live in groups) and do not separate easily from herd companions to mix with other animals. Another critical issue is that animals, in search of food sites, prefer to use established paths, streets, open spots, than to penetrate dense shrub areas or to cross rugged terrain areas [14]. In this case, it can be observed in Figure 5 some common trajectories associated with the direction of the contour lines, and this may indicate that the animals prefer to walk towards clean and flat terrain. It is also pointed out some trajectories close to the picket fence; similar behavior was observed by Handcock et al. [12].

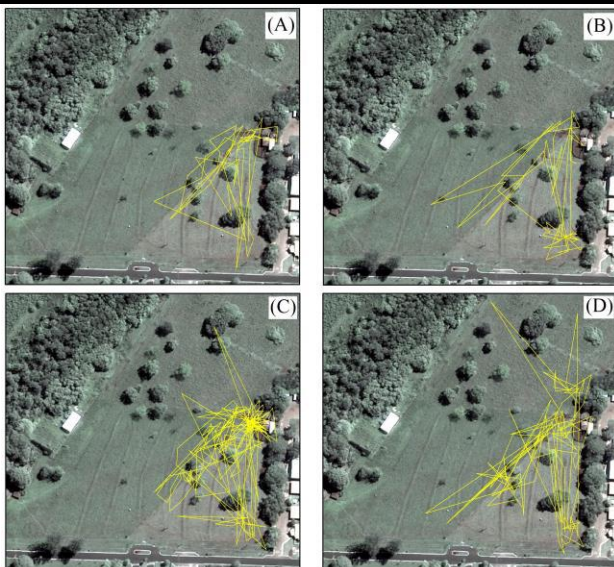

Fig. 5. Trajectories of four animals on an experimental pasture at Beef Cattle Embrapa, Campo Grande, MS, Brazil. Figures A, B, C, and D show the trajectories collected through collars #0001, #0003, #0004 and #0006, respectively. GeoEye-1 image obtained on October 9th, 2011 on the background, show non-RGB composition (3, 2, 1) merged with panchromatic band.

Another common point observed in the study refers to some trajectories towards the trees in the pasture, indicating the search of shaded areas that present more favorable microclimatic conditions. In addition, preferential paths were observed towards the corral, and this mobility may be associated with the search for water and supplementary feeding (salt, feed, etc.). Santos et al. [14] report that within the pasture environment, the animals prioritize their primary physiological needs that is, water consumption and thermal regulation and, in turn, they directly influence the mobility of the herd. Thus, areas near water sources are grazed more frequently [15]. As shown in Figure 6, this bovine behavior was spatially confirmed. The animals with the collars # 0001 and # 0004 had central points of the trajectories performed by each animal (local center) in areas closer to the corral due to the likely search for water and supplementary feeding. On the other hand, the animals with the collars # 0003 and # 0006 displayed a local center in areas with trees which provide microclimatic conditions more favorable to animal welfare due to shading.



Fig. 6. Visualization of the local center of the trajectories of each bovine in experimental pasture area at Beef Cattle Embrapa, Campo Grande, MS, Brazil. On the background, GeoEye-1 image on October 9th 2011, show non-RGB composition (3, 2, 1) merged with panchromatic band.

Figure 7 shows the trajectories performed by the cattle associated with NDVI map and daily real evapotranspiration (ET) estimated from Landsat 5 TM image on November 5th, 2009. For experimental picket pasture, NDVI varied from 0.20 to 0.65 (Figure 7A), and ET ranged from 1.25 to 2.75 mm / day (Figure 7B). Greater NDVI values point to better food availability for the herd; however, the spatial resolution of the Landsat 5 TM image (30 meters) in small pasture paddocks (<10 ha) resulted in a limitation. Therefore, canopies of trees located in the pasture influenced the values of NDVI and ET in some pixels. An example of this influence was found in pixels of the image representing the geographical region of the corral, which presented overestimated values for both NDVI (0.51 to 0.60) and ET (2.26 to 2.55 mm/day).

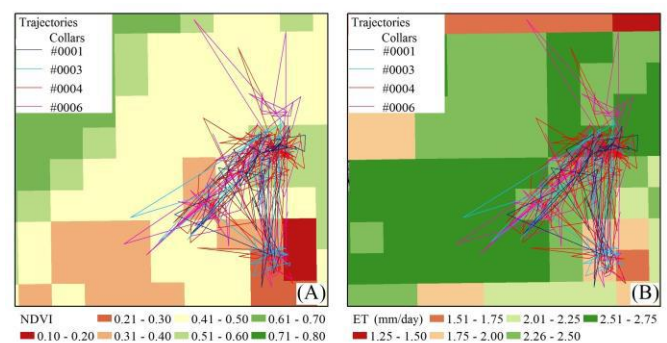

Fig. 7. Trajectories performed by the animals (collars #0001, #0003, #0004 and #0006) associated with NDVI maps (A) and daily real evapotranspiration (ET, mm/day) (B), estimated using Landsat 5 TM image on May 11th 2009.

For pastures fields of less than 10 hectares, high spatial resolution images (pixels <5 meters) may be a more interesting alternative to evaluate the relationship between cattle mobility and biophysical parameters of pastures [12]. Figures 8A and 8B show the NDVI estimated from GeoEye-1 (09/10/2011) and WorldView-2 (4/13/2013) image, respectively, with a pixel size smaller than 2 meters. It can be seen in these figures that NDVI values greater than 0.60 stood out particularly in representative pixels of tree canopies. This is much more evidenced in Figure 8A, where it is possible to observe good class discrimination with NDVI values that represent grass (0.20 to 0.50), tree canopy (NDVI > 0.60) and built-up areas (corral, sheds, roads, etc., with NDVI < 0.10). In this case, it is likely that this better separation between pasture and shrub vegetation may be related to the seasonal climatic variations of the region, that is, in periods of low rainfall, pasture has a more significant water restriction when compared to the shrub vegetation that has a deeper root system, therefore, smaller drop of the canopy vigor. For the day April 13th 2013 (Figure 8B), the pasture presented values of NDVI within the range from 0.30 to 0.78. However, it is observed that most of the pasture was distinguished in two NDVI intervals, one interval with values ranging from 0.30 to 0.50 and the other one between 0.50 to 0.78. Although the cattle trajectory data are from 2009 and the NDVI values shown in Figures 8A and 8B are for the scenes of October 9th 2011 and April 13th 2013, respectively, it is possible to notice the application potential of these trajectories for possible behavioral evaluations of cattle on pasture. For example, when trajectories are associated with NDVI, it is possible to evaluate whether the animals grazed in areas of the pasture with indicative of high plant biomass and the period they remained in these areas of greater food supply. In addition, other assessments are possible, such as evaluating the preference for grass types. In this sense, Hancock et al. [12] used NDVI values to assess the behavior of the animals by applying the Landscape Preference Index (LPI) that is given by the ratio between the proportionate time spent in the area of interest and the proportion of the area of interest in relation to the complete available area. The authors observed a variation in the individual behavior of the animals and also found the cattle preference for greener vegetation. However, the LPI contrasted with the total time that the animals remained in pasture areas with different levels of NDVI. One example was the high values of LPI near fences and gates, areas of greater soil compaction caused by trampling of the animals and that usually present soil exposure and, consequently, low NDVI values.

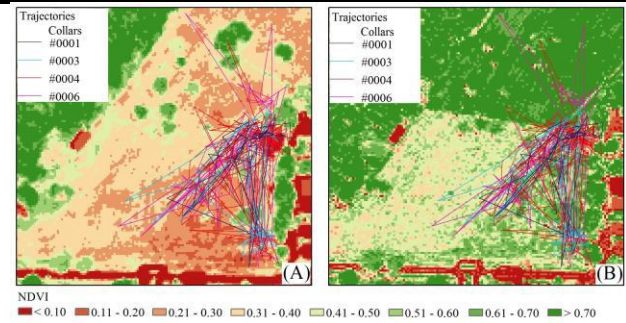

Fig. 8. Trajectories performed by the animals (collars #0001, #0003, #0004 and #0006) associated with NDVI maps estimated from GeoEye-1 image on October 9th 2011 (A) and WorldView-2 on April 13th 2013 (B).

Overall, for the study period, a similar mobility pattern was observed for all animals, that is, they remained mainly in the region closest to the corral and to the water fountain, where NDVI values were lower. Besides, the trajectories performed by the animals indicate that less than 50% of the area of the picket was visited or used for grazing. This information can contribute strategically, for example, so that food supplementation is carried out in troughs located in scarcely visited areas of the field, thus stimulating the animals to move and use more uniformly the available forage.

IV. CONCLUSIONS

This study explored the concept of geotracking as an original strategy whose goal is the better understanding of the behavior of the herd on pasture and, through this case study, to evaluate the application potential related to the achievement of information for cattle sustainable management. Animal mobility data associated with satellite images are promising for the evaluation of the spatial-temporal behavior of cattle and environmental interactions related to mobility, which makes it possible to observe the existence of a typical behavior pattern of the animals. In this case, the results obtained in the study reveal the potential of this information for the implementation of a robust cattle farming geodecision system that makes it possible to determine the spatial-temporal origin of production and to contribute to adequate production practices, assuring food quality and safety combined with environmental sustainability.

REFERENCES

- [1] Lara, J. A. F. de.; Soares, A. L.; Lima, P. N. de.; Ida, E. I.; Shimokomaki, M. (2003). Rastreabilidade da carne bovina: uma exigência para a segurança alimentar. *Seminário: Ciências Agrárias*, Londrina, 24 (1), pp. 143-148.

- [2] Fitz, P. R. (2001). O poder da geoinformação. *Diálogo*, Canoas, RS, 1 (2), pp. 145-154.
- [3] Batistella, M.; Carvalho, G. R.; Pierozzi Júnior, I. (2008). Análise e tendências para o mercado de geoinformação no Brasil. In: Batistella, M.; Moran, E. F. (Org). *Geoinformação e monitoramento ambiental na América Latina*. São Paulo: Editora Senac São Paulo. 283 p.
- [4] Batistella, M.; Ometto, A.; Viau, A.; Chuzel, G. (2006). Geotraceability in agricultural chains, an urgent demand in Brazilian agribusiness. In: *Global Conference on Sustainable Product Development and Life Cycle Engineering*, 4., São Carlos, SP. *Proceedings...* São Carlos: Suprema, 5 p.
- [5] Ometto, A.; Batistella, M.; Guelere Filho, A.; Chuzel, G.; Viau, A. (2007). Geotraceability and life cycle assessment in environmental life cycle management: towards sustainability. In: Loureiro, G.; Curran, R. (Ed.). *Complex systems concurrent engineering*. London: Springer. pp. 673-679.
- [6] Visoli, M. C.; Ternes, S.; Chanut, J.-P.; Pinet, F.; Miralles, A.; Bernard, S.; Souza, G. (2009). A new information system for tracing geolocations of bovine cattle. In: *Congrès Inforsid*, 27., 2009, Toulouse. *Atelier systèmes d'Information et de décision pour l'Environnement*. Inforsid. pp. 74-83.
- [7] Oger, R.; Krafft, A.; Buffet, D.; Debord, M. (2010). Geotraceability: an innovative concept to enhance conventional traceability in the agri-food chain. *Biotechnologie, Agronomie, Société et Environnement*, 14 (4), p. 633-642. Available at: <https://popups.uliege.be/1780-4507/index.php?id=17126&file=1&pid=6375>. Consulted on: May 08, 2019.
- [8] Paranhos da Costa, M. J. R.; Costa e Silva, E. V. (2007). Aspectos básicos do comportamento social de bovinos. *Revista Brasileira de Reprodução Animal*, Belo Horizonte, 31 (2), pp. 172-176. Available at: <http://www.cbra.org.br/pages/publicacoes/rbra/download/172.pdf>. Consulted on: May 08, 2019.
- [9] Faure, P.; Rameau, P.; Monod, M. O.; Moiroux, L. (2009). Development of electronic collars to track and trace cattle. In: IICA (Coord.). *OTAG Booklet - New tools for precision livestock management*. Montevideo: IICA. pp. 32-37. Part 3. Available at: <https://ainfo.cnptia.embrapa.br/digital/bitstream/item/31267/1/172468.pdf>. Consulted on: May 08, 2019.
- [10] Batistella, M.; Bolfe, E. L.; Victoria, D. C.; Custodio, D. O.; Silva, G. B. S.; Drucker, D. P. (2012). *SOMABRASIL: Sistema de Observação e Monitoramento da Agricultura no Brasil*. Campinas: Embrapa Monitoramento por Satélite. 11 p. (Comunicado Técnico, 29). Available at: <https://ainfo.cnptia.embrapa.br/digital/bitstream/item/69644/1/026-12.pdf>. Consulted on: May 08, 2019.
- [11] Andrade, R. G.; Sediya, G. C.; Paz, A. R.; Lima, E. P.; Facco, A. G. (2012). Geotecnologias aplicadas à avaliação de parâmetros biofísicos do Pantanal. *Pesquisa Agropecuária Brasileira*, 47, (9), pp. 1227-1234.
- [12] Handcock, R. N.; Swain, D. L.; Bishop-Hurley, G. J.; Patison, K. P.; Wark, T.; Valencia, P.; Corke, P.; O'Neill, C. J. (2009). Monitoring animal behavior and environmental interactions using wireless sensor networks, GPS collars and satellite remote sensing. *Sensors*, 9, pp. 3586-3603.
- [13] Silveira, I. D. B.; Fischer, V.; Mendonça, G. de. (2006). Comportamento de bovinos de corte em pista de remate. *Ciência Rural*, Santa Maria, 36 (5), pp. 1529-1533.
- [14] Santos, B. R. C. dos; Voltolini, T. V.; Salla, L. E. (2010). Comportamento de pastoreio. *Revista Eletrônica de Veterinária*, 11 (4), pp. 1-33. Available at: <https://ainfo.cnptia.embrapa.br/digital/bitstream/item/23498/1/Tadeu-2010.pdf>. Consulted on: May 08, 2019.
- [15] Senft, R. L.; Rittenhouse, L. R.; Woodmansee, R. G. (1985). Factors influencing selection of resting sites by cattle on shortgrass steppe. *Journal Range Management*, Denver, 38 (4), pp. 295-299.